

OAP900

Quick Installation Guide

05-2016 / v1.0

Edimax Technology Co., Ltd.

No.3, Wu-Chuan 3rd Road, Wu-Gu, New Taipei City 24891, Taiwan

Email: support@edimax.com.tw

Edimax Technology Europe B.V.

Fijenhof 2, 5652 AE Eindhoven, The Netherlands

Email: support@edimax.nl

Edimax Computer Company

3350 Scott Blvd., Bldg.15 Santa Clara, CA 95054, USA

Live Tech Support: 1(800) 652-6776

Email: support@edimax.com

I. Product Information

I-1. Package Contents

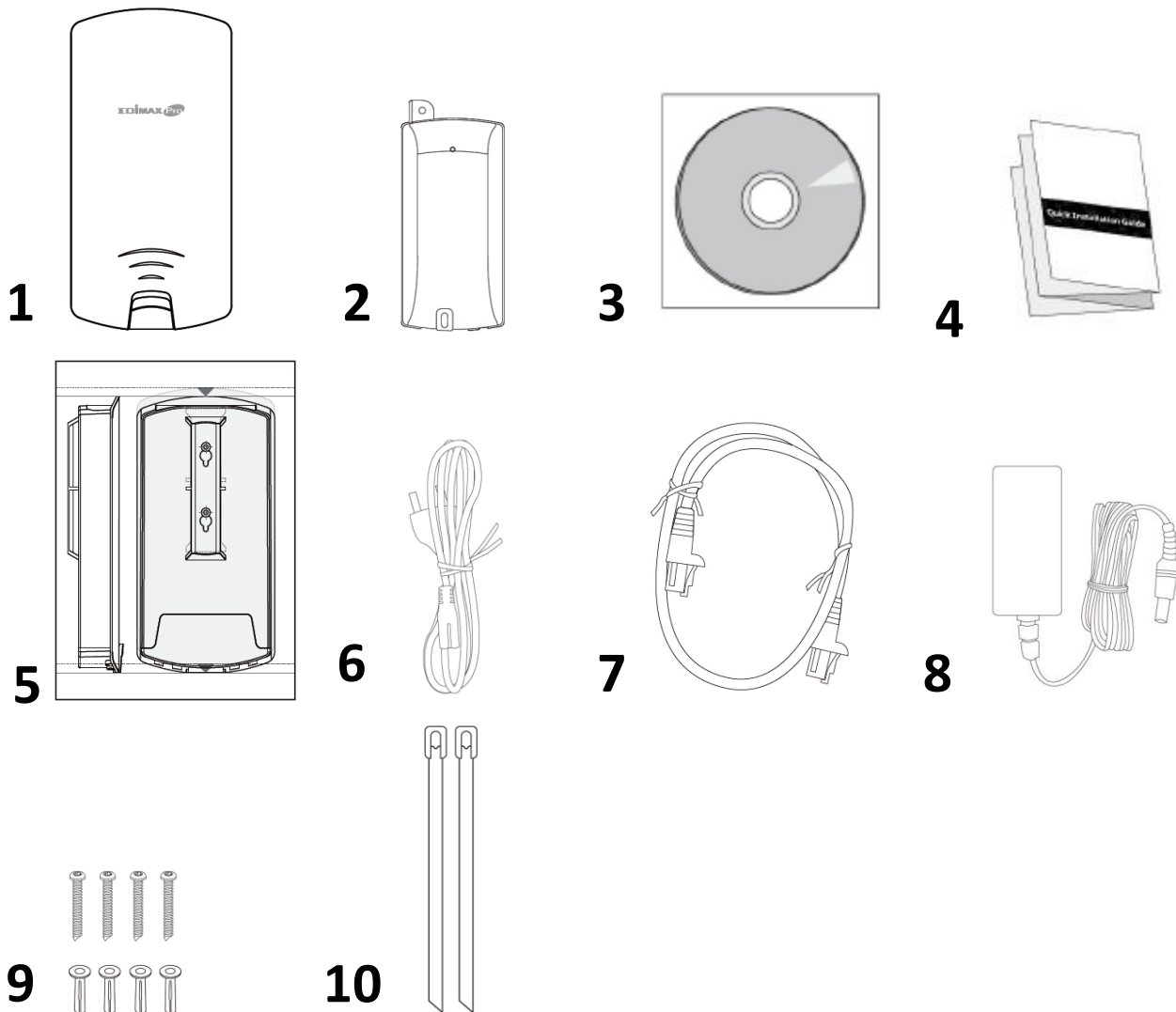

1. Access Point

2. PoE Injector

3. CD

4. Quick Installation Guide

5. Wall Mount Screw Template

6. Power Cord

7. Ethernet Cable

8. Power Adapter

9. Wall Mount Screw Set

10. Pole Mount Set

I-2. System Requirements

- Ethernet cable, PoE Injector
- Computer with web browser for access point configuration

I-3. Hardware Overview

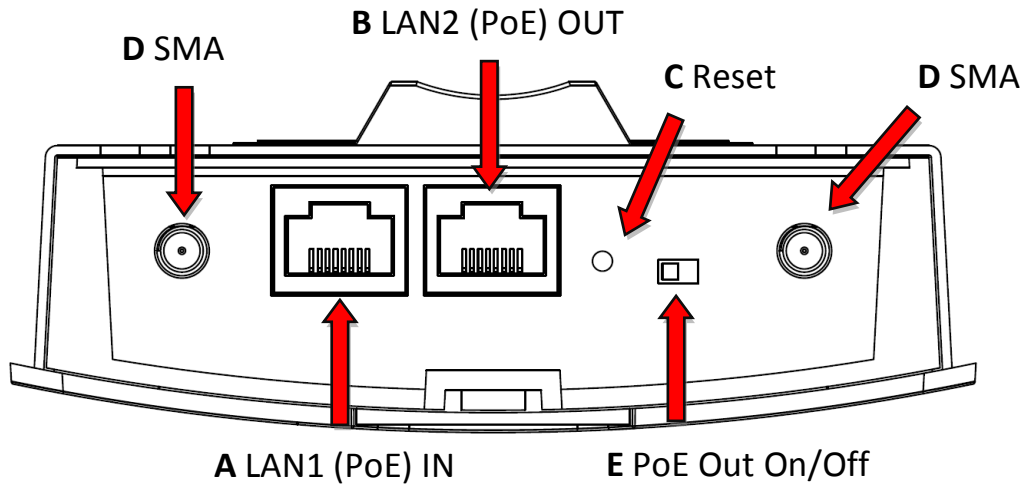

- A.** LAN1 port with Power over Ethernet (Passive PoE) IN.
- B.** LAN2 port with Power over Ethernet (Passive PoE) OUT.
- C.** Reset the access point to factory default settings
- D.** SMA connector for optional antenna.
- E.** Switch the LAN2 (Passive PoE) OUT on/off.

⚠ WARNING

DC48V Voltage on the LAN2, Turn off the slide switch before use.

I-4. LED Status

LED Behavior		
Power	Blue	The access point is on.
	Off	The access point is off.
LAN 1 & 2	Blue	LAN port is connected.
	Flashing	Activity (transferring and receiving)
	Off	LAN port is unconnected.
Wireless (Client mode only)	Blue	Wireless enabled.
	Flashing	Excellent/Good/Medium/Bad for RSSI Signal Strength.
	Off	Wireless disabled.

I-5. Reset

If you experience problems with your access point, you can reset the device back to its factory settings. This resets all settings back to default.

1. Press and hold the reset button on the access point for at least 10 seconds. Then release the button.



You may need to use a pencil or similar sharp object to push the reset button.

2. Wait for the access point to restart. The access point is ready for setup when the LED is **blue**.

I-6. Mounting

The access point includes a mount for wall or pole which requires some assembly.

Wall Mount

1. Attach the mount and access point to a wall using the included screws and plugs.

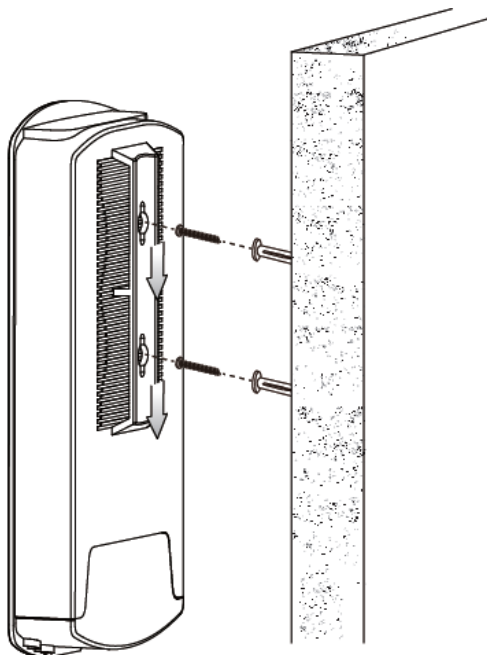

Pole Mount

2. Fix the mount and access point to a pole using the included pole mount straps.

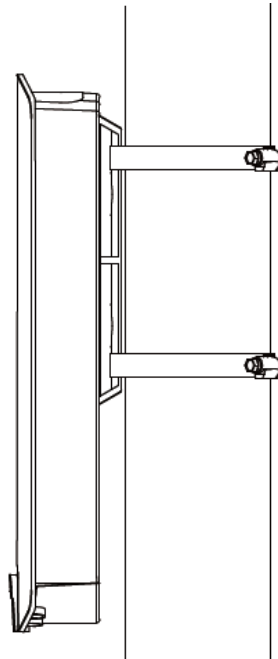

II. Quick Setup

The OAP900 Long Range 802.11ac Outdoor Access Point features a range of powerful functions:

- 802.11ac high-speed wireless technology
- 16 SSIDs for management
- SNMP v1/v2c/v3

Your access point can be up and running in just a few minutes. It can function as a standalone access point (AP mode), as part of an AP array (Managed AP mode), or as a client bridge for WISP last-mile services (Client Bridge mode).

For use as a Managed AP in an AP array, the access point will automatically switch mode when an AP Controller is configured as described in **II-3**.

Managed AP Mode: Edimax Pro NMS.

II-1. Passive PoE Injector



Do not connect a non-PoE device to the access point's LAN2 (PoE Out) port. The LAN2 port outputs 48 V and can damage a non PoE device.

1. Connect the access point's LAN1 (PoE In) port to the PoE injector's PoE port via Ethernet cable.



2. Use an Ethernet cable to connect the access point's LAN port to your network: router, access point or switch. If it's more convenient for initial setup, you can connect a computer directly to the access point's LAN port instead.

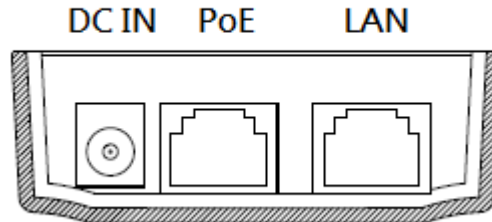

3. Connect the PoE injector to a power source using the included power adapter. Wait a moment for the access point to start up. The access point is ready when the LED is **blue**.

II-2. AP Mode

1. Enter the access point's IP address into the URL bar of a web browser. The default IP is **192.168.2.2**. If the AP is connected to a DHCP server, ensure you use the correct address.



2. You will be prompted for a user name and password. Enter the default username "admin" and the default password "1234".

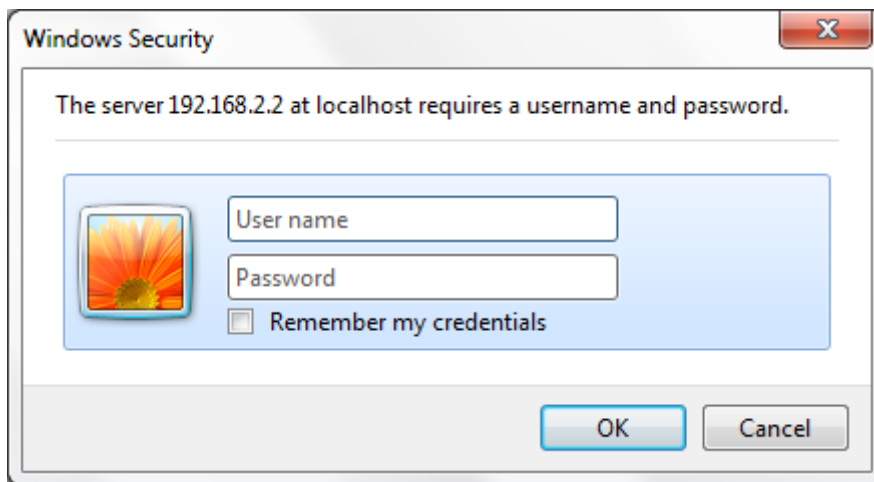

3. You will arrive at the "System Information" screen shown below.

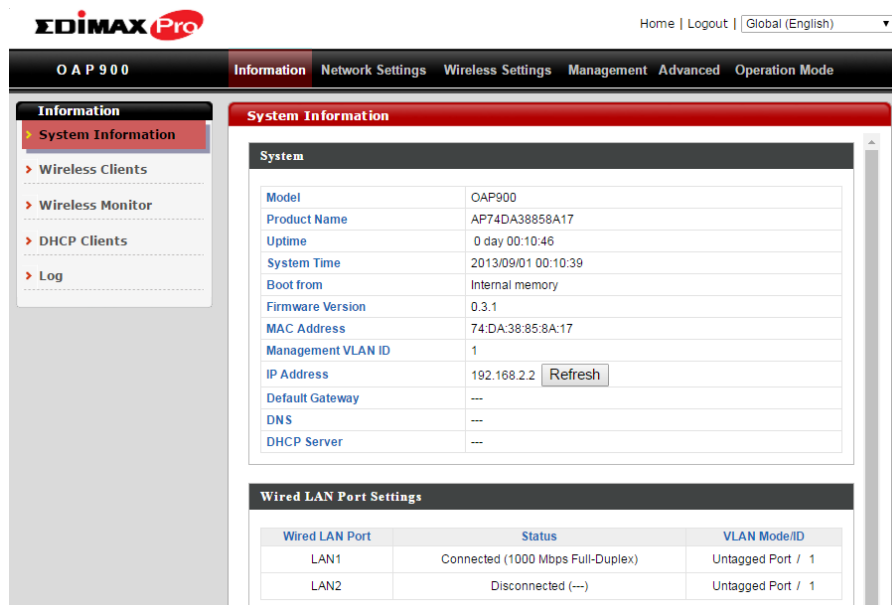

The screenshot shows the EDIMAX Pro OAP900 web interface. The top navigation bar includes "Home | Logout | Global (English)". The main menu has "Information", "Network Settings", "Wireless Settings", "Management", "Advanced", and "Operation Mode". The "Information" section is expanded to show "System Information", "Wireless Clients", "Wireless Monitor", "DHCP Clients", and "Log". The "System Information" screen displays the following details:

System	
Model	OAP900
Product Name	AP74DA38858A17
Uptime	0 day 00:10:46
System Time	2013/09/01 00:10:39
Boot from	Internal memory
Firmware Version	0.3.1
MAC Address	74:DA:38:85:8A:17
Management VLAN ID	1
IP Address	192.168.2.2 <input type="button" value="Refresh"/>
Default Gateway	---
DNS	---
DHCP Server	---

Wired LAN Port Settings		
Wired LAN Port	Status	VLAN Mode/ID
LAN1	Connected (1000 Mbps Full-Duplex)	Untagged Port / 1
LAN2	Disconnected (---)	Untagged Port / 1

The next steps will help you to configure the following basic settings of the access point:

- LAN IP Address
- 5GHz SSID & Security
- Administrator Name & Password
- Time & Date



It is recommended you configure these settings before using the access point.

1. To change the access point's LAN IP address, go to **"Network Settings"** > **"LAN-side IP Address"** and you will see the screen below.

LAN-side IP Address	
IP Address Assignment	DHCP Client ▼
IP Address	192.168.2.2
Subnet Mask	255.255.255.0
Default Gateway	From DHCP ▼ <input type="text"/>
Primary DNS Address	From DHCP ▼ <input type="text" value="0.0.0.0"/>
Secondary DNS Address	From DHCP ▼ <input type="text" value="0.0.0.0"/>

2. Enter the IP address settings you wish to use for your access point. You can use a dynamic (DHCP) or static IP address, depending on your network environment. Click "Apply" to save the changes and wait a few moments for the access point to reload.



When you change your access point's IP address, you need to use the new IP address to access the browser based configuration interface instead of the default IP 192.168.2.2.

3. To change the SSID of your access point's 5GHz wireless network(s), go to **"Wireless Settings"** > **"5GHz 11ac"** > **"Basic"**. Enter the new SSID for your 2.4GHz wireless network in the "SSID1" field and click "Apply".



To utilize multiple 5GHz SSIDs, open the drop down menu labelled "Enable SSID number" and select how many SSIDs you require. Then enter a new SSID in the corresponding numbered fields below, before clicking "Apply".

5GHz Basic Settings	
Wireless	<input checked="" type="radio"/> Enable <input type="radio"/> Disable
Band	11a/n/ac ▼
Enable SSID number	1 ▼
SSID1	OAP900-858A17 VLAN ID 1
Auto Channel	<input checked="" type="radio"/> Enable <input type="radio"/> Disable
Auto Channel Range	Band 3 ▼
Auto Channel Interval	One day ▼ <input type="checkbox"/> Change channel even if clients are connected
Channel Bandwidth	Auto 80/40/20 MHz ▼
BSS BasicRate Set	6,12,24 Mbps ▼

4. To configure the security of your access point's 5GHz wireless network(s), go to **“Wireless Settings”** > **“5GHz 11ac 11an”** > **“Security”**. Select an **“Authentication Method”** and enter a **“Pre-shared Key”** or **“Encryption Key”** depending on your choice, then click **“Apply”**.



*If using multiple SSIDs, specify which SSID to configure using the **“SSID”** drop down menu.*

5GHz Wireless Security Settings	
SSID	OAP900-858A17 ▼
Broadcast SSID	Enable ▼
Wireless Client Isolation	Disable ▼
Load Balancing	100 /100
Authentication Method	No Authentication ▼
Additional Authentication	No additional authentication ▼

5. To change the administrator name and password for the browser based configuration interface, go to **“Management”** > **“Admin”**.

Account to Manage This Device	
Administrator Name	<input type="text" value="admin"/>
Administrator Password	<input type="password" value="•••••"/> (4-32 Characters)
	<input type="password" value="•••••"/> (Confirm)
<input type="button" value="Apply"/>	

- Complete the “Administrator Name” and “Administrator Password” fields and click “Apply”.
- To set the correct time for your access point, go to “Management” > “Date and Time Settings”.

Date and Time Settings	
Local Time	2012 Year Jan Month 1 Day 0 Hours 00 Minutes 00 Seconds
<input type="button" value="Acquire Current Time from Your PC"/>	
NTP Time Server	
Use NTP	<input type="checkbox"/> Enable
Server Name	<input type="text"/>
Update Interval	24 hours
Time Zone	
Time Zone	(GMT) Greenwich Mean Time: Dublin, Edinburgh, Lisbon, London

- Set the correct time and time zone for your access point using the drop down menus. The access point also supports NTP (Network Time Protocol) so alternatively you can enter the host name or IP address of a time server. Click “Apply” when you are finished.



You can use the “Acquire Current Time from your PC” button if you wish to set the access point to the same time as your PC.

- The basic settings of your access point are now configured.

II-3. Managed AP Mode: Edimax Pro NMS

Edimax Pro Network Management Suite (NMS) supports the central management of a group of access points, otherwise known as an AP Array. NMS supports up to 16 Edimax Pro access points with no additional wireless controller required or 128 access points with the APC 500 AP controller - reducing costs and facilitating efficient remote AP management.

Edimax Pro NMS is simple to setup. An overview of the system is shown below:

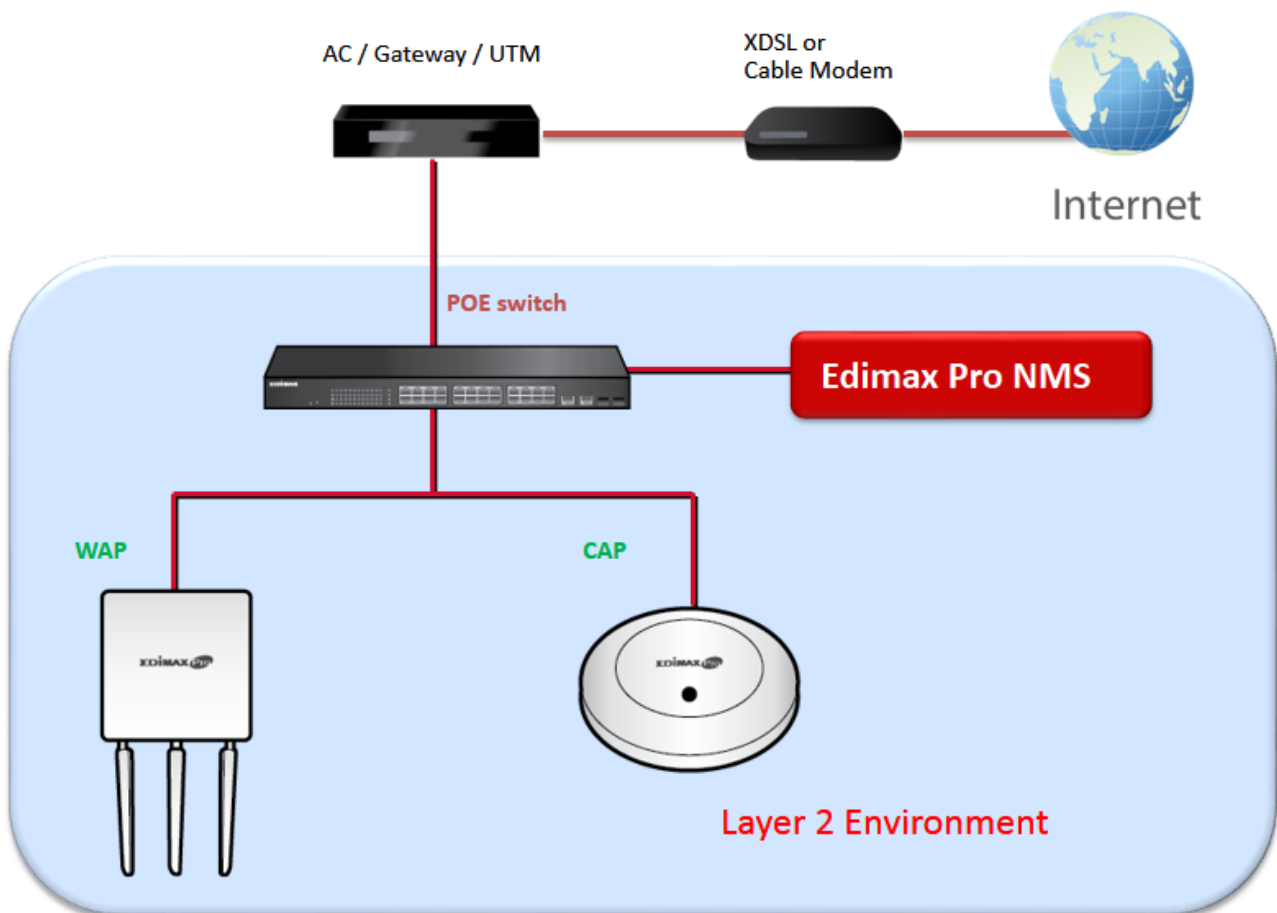

One AP (access point) is designated as the AP Controller (master) and other connected Edimax Pro APs are automatically designated as Managed APs (slaves). Using Edimax Pro NMS you can monitor, configure and manage all Managed APs (up to 128) from the single AP Controller.

The OAP900 functions as a Managed AP and cannot act as an AP Controller.

When using an Edimax NMS AP controller, other connected APs are automatically set to Managed APs. In the case that the AP Controller cannot find your OAP900 as a Managed AP, you can configure the setting manually as below:

1. Ensure all APs including your OAP900 are connected to an Ethernet or PoE switch which is connected to a gateway/router.

 **You can use your router as a DHCP server or you can later configure your AP Controller as a DHCP server.**

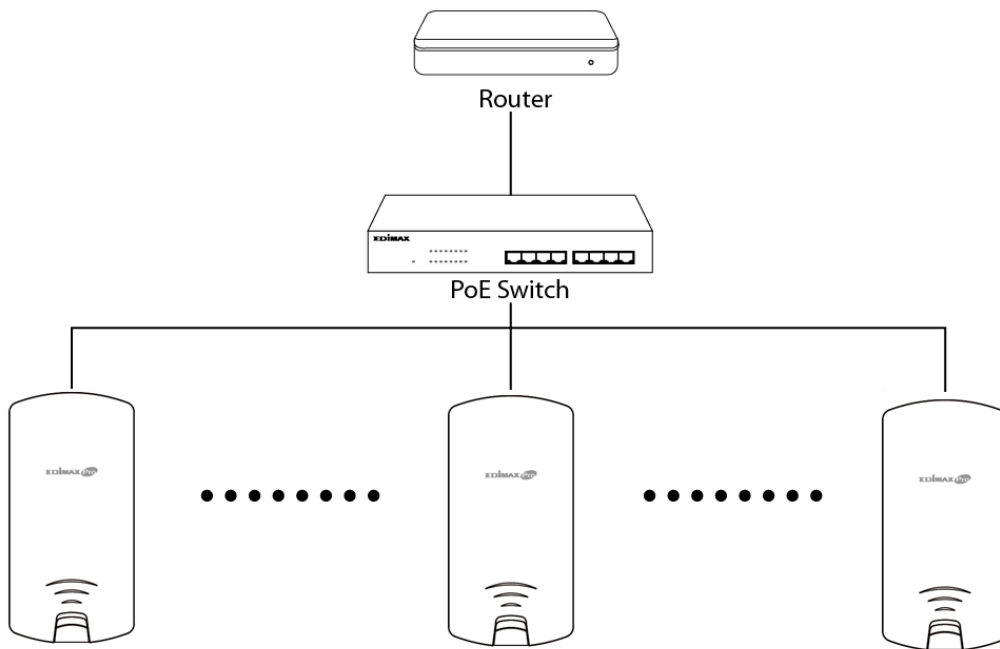

2. Ensure all APs are powered on and check LEDs.

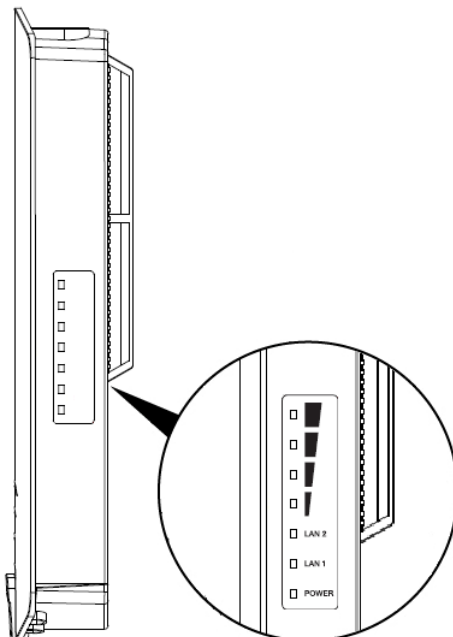

- 3.** Ensure you have setup and designated one AP as the AP Controller which will manage all other connected APs (up to 128 depending on model).

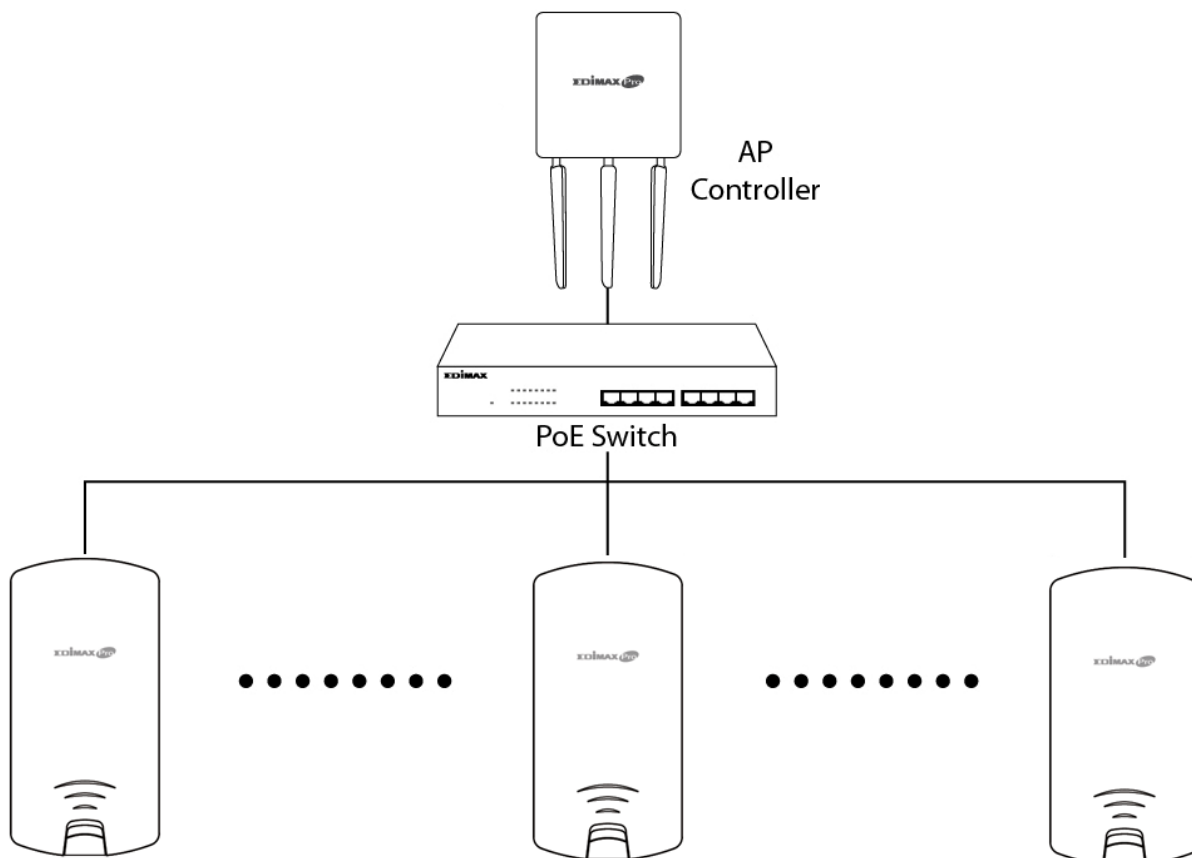

- 4.** Connect a computer to the OAP900 via PoE switch using an Ethernet cable.

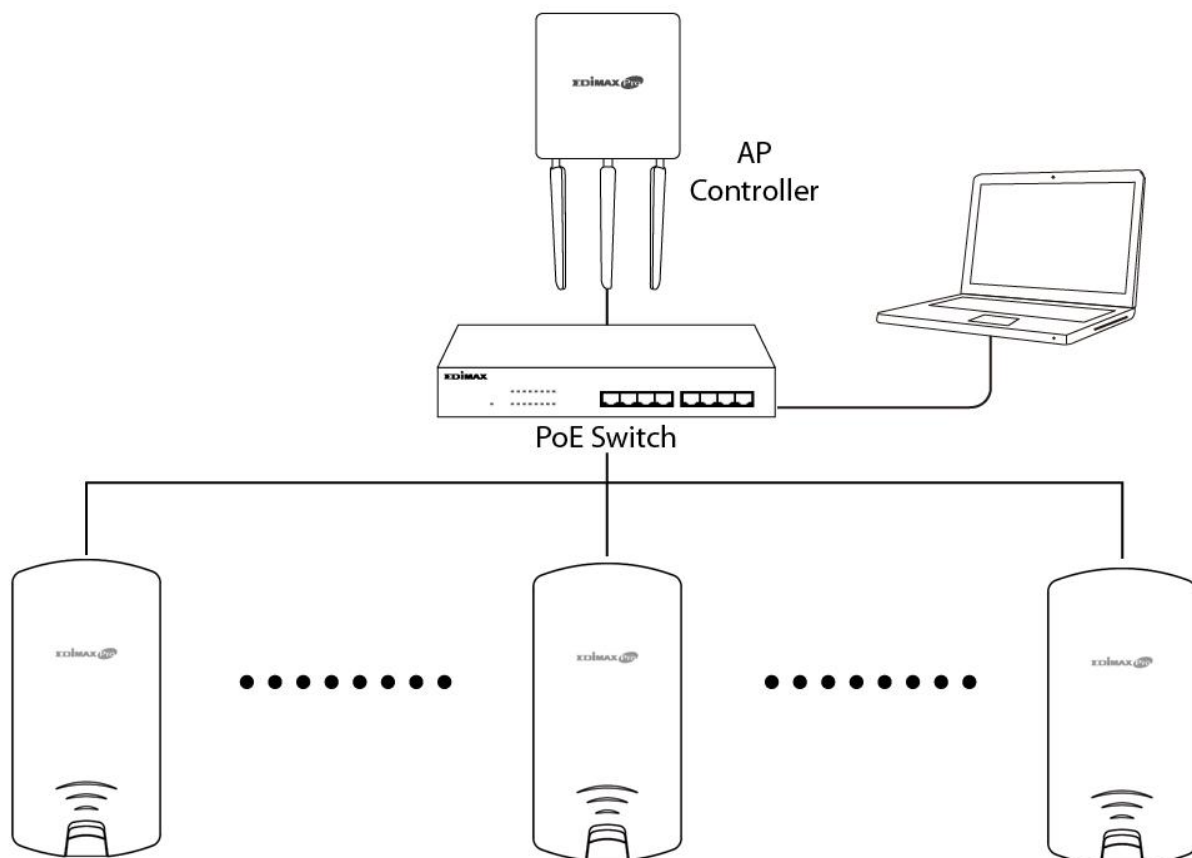

5. Open a web browser and enter the OAP900's IP address in the address field. The default IP address is **192.168.2.2**



6. Enter the username & password to login. The default username & password are **admin** & **1234**.
7. You will arrive at the Edimax Pro NMS Dashboard. Go to **“Operation Mode”** and select **“Managed AP Mode”** from the drop down menu.

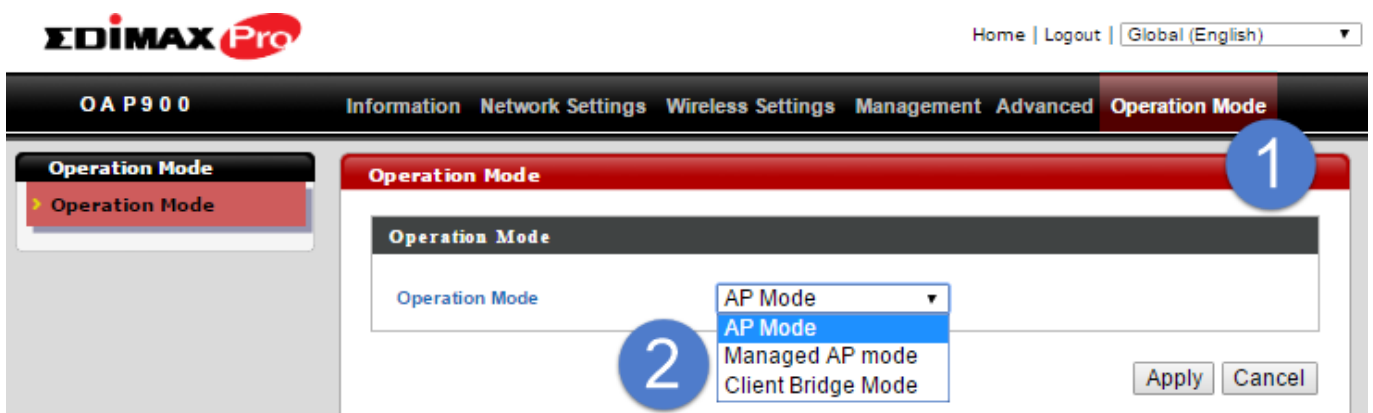

8. Click “Apply” to save the settings and your AP Controller & Managed APs should be fully functional. Use Edimax NMS on your AP controller to manage & monitor your Managed APs.



Refer to your AP controller’s user manual for help with Edimax NMS.

III-4. Client Bridge Mode

Client Bridge mode enables the OAP900 to wirelessly connect to an AP’s SSID while remaining in the same IP address range as that AP – the WAN and LAN are on the same subnet. This is ideal for last-mile solutions. Settings here are saved as **profiles**.

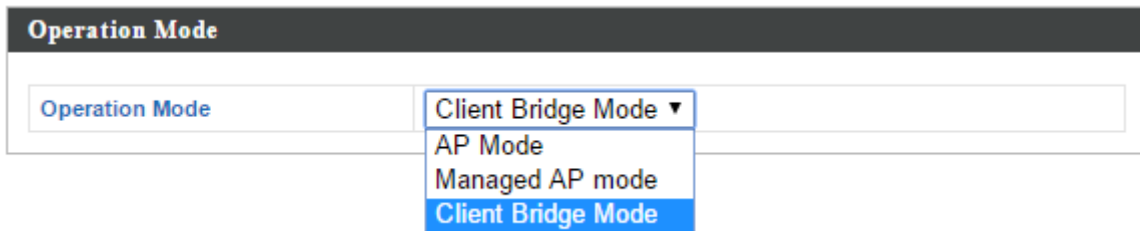

1. Enter the access point’s IP address into the URL bar of a web browser. The default IP is **192.168.2.2**. If the AP is connected to a DHCP server, ensure you use the correct address.



2. Enter the default username “admin” and the default password “1234”, and then go to **Wireless Settings → Wireless Extender**.

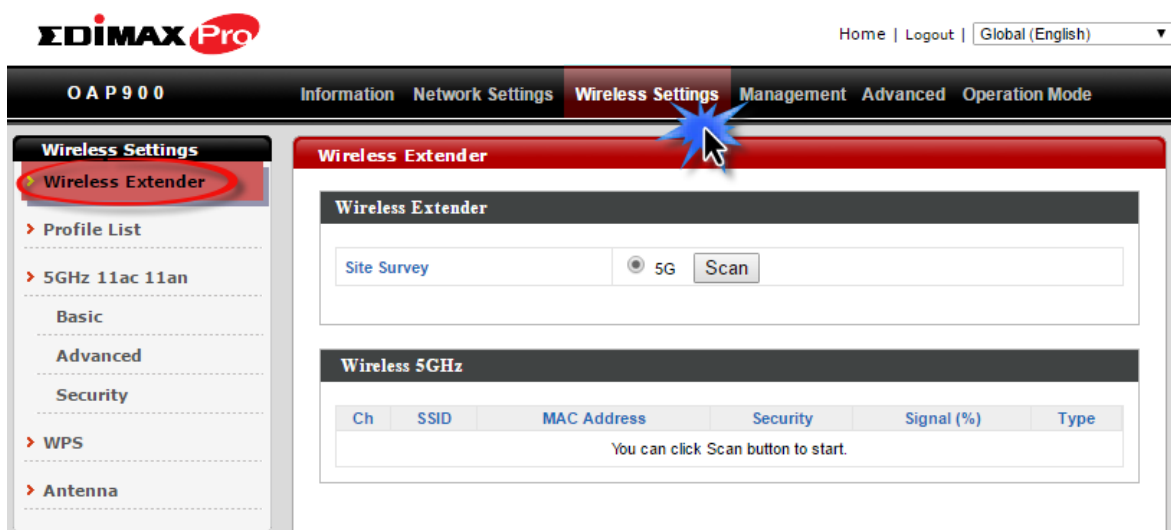

3. Click **Scan** to search for and display available SSIDs and click **Select** to connect to an available source SSID.

Wireless Extender

Site Survey 5G

Wireless 5GHz (1 Accesspoints)

Select	Ch	SSID	MAC Address	Security	Signal (%)	Type
<input type="radio"/>	36	Edimax 5G	74:DA:38:06:E1:91	WPA1PSKWPA2PSK /TKIPAES	67	ac

4. Enter the encryption information for the SSID and then click **Connect**.

Wireless Create profile

SSID	Edimax 5G
Authentication Method	WPA-PSK ▼
WPA Type	WPA2 Only ▼
Encryption Type	AES ▼
Pre-shared Key Type	Passphrase ▼
Pre-shared Key	12345678

COPYRIGHT

Copyright © Edimax Technology Co., Ltd. all rights reserved. No part of this publication may be reproduced, transmitted, transcribed, stored in a retrieval system, or translated into any language or computer language, in any form or by any means, electronic, mechanical, magnetic, optical, chemical, manual or otherwise, without the prior written permission from Edimax Technology Co., Ltd.

Edimax Technology Co., Ltd. makes no representations or warranties, either expressed or implied, with respect to the contents hereof and specifically disclaims any warranties, merchantability, or fitness for any particular purpose. Any software described in this manual is sold or licensed as is. Should the programs prove defective following their purchase, the buyer (and not this company, its distributor, or its dealer) assumes the entire cost of all necessary servicing, repair, and any incidental or consequential damages resulting from any defect in the software. Edimax Technology Co., Ltd. reserves the right to revise this publication and to make changes from time to time in the contents hereof without the obligation to notify any person of such revision or changes.

The product you have purchased and the setup screen may appear slightly different from those shown in this QIG. The software and specifications are subject to change without notice. Please visit our website www.edimax.com for updates. All brand and product names mentioned in this manual are trademarks and/or registered trademarks of their respective holders.

Federal Communication Commission Interference Statement

This equipment has been tested and found to comply with the limits for a Class B digital device, pursuant to Part 15 of FCC Rules. These limits are designed to provide reasonable protection against harmful interference in a residential installation. This equipment generates, uses, and can radiate radio frequency energy and, if not installed and used in accordance with the instructions, may cause harmful interference to radio communications. However, there is no guarantee that interference will not occur in a particular installation. If this equipment does cause harmful interference to radio or television reception, which can be determined by turning the equipment off and on, the user is encouraged to try to correct the interference by one or more of the following measures:

1. Reorient or relocate the receiving antenna.
2. Increase the separation between the equipment and receiver.
3. Connect the equipment into an outlet on a circuit different from that to which the receiver is connected.
4. Consult the dealer or an experienced radio technician for help.

FCC Caution

This device and its antenna must not be co-located or operating in conjunction with any other antenna or transmitter. This device complies with Part 15 of the FCC Rules. Operation is subject to the following two conditions: (1) this device may not cause harmful interference, and (2) this device must accept any interference received, including interference that may cause undesired operation. Any changes or modifications not expressly approved by the party responsible for compliance could void the authority to operate equipment.

Federal Communications Commission (FCC) Radiation Exposure Statement

This equipment complies with FCC radiation exposure set forth for an uncontrolled environment. In order to avoid the possibility of exceeding the FCC radio frequency exposure limits, human proximity to the antenna shall not be less than 2.5cm (1 inch) during normal operation.

Federal Communications Commission (FCC) RF Exposure Requirements

SAR compliance has been established in the laptop computer(s) configurations with PCMCIA slot on the side near the center, as tested in the application for certification, and can be used in laptop computer(s) with substantially similar physical dimensions, construction, and electrical and RF characteristics. Use in other devices such as PDAs or lap pads is not authorized. This transmitter is restricted for use with the specific antenna tested in the application for certification. The antenna(s) used for this transmitter must not be co-located or operating in conjunction with any other antenna or transmitter.

R&TTE Compliance Statement

This equipment complies with all the requirements of DIRECTIVE 1999/5/EC OF THE EUROPEAN PARLIAMENT AND THE COUNCIL of March 9, 1999 on radio equipment and telecommunication terminal equipment and the mutual recognition of their conformity (R&TTE). The R&TTE Directive repeals and replaces in the directive 98/13/EEC (Telecommunications Terminal Equipment and Satellite Earth Station Equipment) As of April 8, 2000.

Safety

This equipment is designed with the utmost care for the safety of those who install and use it. However, special attention must be paid to the dangers of electric shock and static electricity when working with electrical equipment. All guidelines of this and of the computer manufacture must therefore be allowed at all times to ensure the safe use of the equipment.

EU Countries Intended for Use

The ETSI version of this device is intended for home and office use in Austria, Belgium, Bulgaria, Cyprus, Czech, Denmark, Estonia, Finland, France, Germany, Greece, Hungary, Ireland, Italy, Latvia, Lithuania, Luxembourg, Malta, Netherlands, Poland, Portugal, Romania, Slovakia, Slovenia, Spain, Sweden, Turkey, and United Kingdom. The ETSI version of this device is also authorized for use in EFTA member states: Iceland, Liechtenstein, Norway, and Switzerland.

EU Countries Not Intended for Use

None

EU Declaration of Conformity

- English:** This equipment is in compliance with the essential requirements and other relevant provisions of Directive 1995/5/EC, 2009/125/EC, 2006/95/EC, 2011/65/EC.
- Français:** Cet équipement est conforme aux exigences essentielles et autres dispositions de la directive 1995/5/CE, 2009/125/CE, 2006/95/CE, 2011/65/CE.
- Čeština:** Toto zařízení je v souladu se základními požadavky a ostatními příslušnými ustanoveními směrnic 1995/5/ES, 2009/125/ES, 2006/95/ES, 2011/65/ES.
- Polski:** Urządzenie jest zgodne z ogólnymi wymaganiami oraz szczególnymi warunkami określonymi Dyrektywą UE 1995/5/EC, 2009/125/EC, 2006/95/EC, 2011/65/EC..
- Română:** Acest echipament este în conformitate cu cerințele esențiale și alte prevederi relevante ale Directivei 1995/5/CE, 2009/125/CE, 2006/95/CE, 2011/65/CE.
- Русский:** Это оборудование соответствует основным требованиям и положениям Директивы 1995/5/EC, 2009/125/EC, 2006/95/EC, 2011/65/EC.
- Magyar:** Ez a berendezés megfelel az alapvető követelményeknek és más vonatkozó irányelveknek (1995/5/EK, 2009/125/EK, 2006/95/EK, 2011/65/EK).
- Türkçe:** Bu cihaz 1995/5/EC, 2009/125/EC, 2006/95/EC, 2011/65/EC direktifleri zorunlu istekler ve diğer hükümlerle ile uyumludur.
- Українська:** Обладнання відповідає вимогам і умовам директиви 1995/5/EC, 2009/125/EC, 2006/95/EC, 2011/65/EC.
- Slovenčina:** Toto zariadenie spĺňa základné požiadavky a ďalšie príslušné ustanovenia smerníc 1995/5/ES, 2009/125/ES, 2006/95/ES, 2011/65/ES.
- Deutsch:** Dieses Gerät erfüllt die Voraussetzungen gemäß den Richtlinien 1995/5/EC, 2009/125/EC, 2006/95/EC, 2011/65/EC.
- Español:** El presente equipo cumple los requisitos esenciales de la Directiva 1995/5/EC, 2009/125/EC, 2006/95/EC, 2011/65/EC.
- Italiano:** Questo apparecchio è conforme ai requisiti essenziali e alle altre disposizioni applicabili della Direttiva 1995/5/CE, 2009/125/CE, 2006/95/CE, 2011/65/CE.
- Nederlands:** Dit apparaat voldoet aan de essentiële eisen en andere van toepassing zijnde bepalingen van richtlijn 1995/5/EC, 2009/125/EC, 2006/95/EC, 2011/65/EC..
- Português:** Este equipamento cumpre os requisitos essenciais da Directiva 1995/5/EC, 2009/125/EC, 2006/95/EC, 2011/65/EC.
- Norsk:** Dette utstyret er i samsvar med de viktigste kravene og andre relevante regler i Direktiv 1995/5/EC, 2009/125/EC, 2006/95/EC, 2011/65/EC.
- Svenska:** Denna utrustning är i överensstämmelse med de väsentliga kraven och övriga relevanta bestämmelser i direktiv 1995/5/EG, 2009/125/EG, 2006/95/EG, 2011/65/EG.
- Dansk:** Dette udstyr er i overensstemmelse med de væsentligste krav og andre relevante forordninger i direktiv 1995/5/EC, 2009/125/EC, 2006/95/EC, 2011/65/EC.
- suomen kieli:** Tämä laite täyttää direktiivien 1995/5/EY, 2009/125/EY, 2006/95/EY, 2011/65/EY oleelliset vaatimukset ja muut asiaankuuluvat määräykset.

FOR USE IN 



WEEE Directive & Product Disposal



At the end of its serviceable life, this product should not be treated as household or general waste. It should be handed over to the applicable collection point for the recycling of electrical and electronic equipment, or returned to the supplier for disposal.

Declaration of Conformity

We, Edimax Technology Co., Ltd., declare under our sole responsibility, that the equipment described below complies with the requirements of the European R&TTE directives.

Equipment: AC900 Outdoor Access Point

Model No.: OAP900

The following European standards for essential requirements have been followed:

Directives 2014/53/EU

Spectrum : ETSI EN 300 328 V1.9.1 (2015-02);
ETSI EN 301 893 V1.8.1(2015-03)

EMC : EN 301 489-1 V1.9.2 (2011-09);
EN301 489-17 V2.2.1(2012-09);
EN 55022:2010/AC:2011
EN 55024:2010

Safety (LVD) : IEC 60950-1:2005 (2nd Edition)+Am 1:2009+Am 2:2013
EN 60950-1:2006+A11:2009+A1:2010+A12:2011+A2:2013

Recommendation 2014/53/EU

EMF : EN 62311:2008

Directives 2014/35/EU

Safety (LVD) : IEC 60950-1:2005 (2nd Edition)+Am 1:2009+Am 2:2013
EN 60950-1:2006+A11:2009+A1:2010+A12:2011+A2:2013

Edimax Technology Co., Ltd.
No. 3, Wu Chuan 3rd Road,
Wu-Ku Industrial Park,
New Taipei City, Taiwan



Date of Signature: Jun, 2016

Signature:

Printed Name:

Albert Chang

Title:

Director

Edimax Technology Co., Ltd.

Notice According to GNU General Public License Version 2

This product includes software that is subject to the GNU General Public License version 2. The program is free software and distributed without any warranty of the author. We offer, valid for at least three years, to give you, for a charge no more than the costs of physically performing source distribution, a complete machine-readable copy of the corresponding source code.

Das Produkt beinhaltet Software, die den Bedingungen der GNU/GPL-Version 2 unterliegt. Das Programm ist eine sog. „Free Software“, der Autor stellt das Programm ohne irgendeine Gewährleistungen zur Verfügung. Wir bieten Ihnen für einen Zeitraum von drei Jahren an, eine vollständige maschinenlesbare Kopie des Quelltextes der Programme zur Verfügung zu stellen – zu nicht höheren Kosten als denen, die durch den physikalischen Kopiervorgang anfallen.

GNU GENERAL PUBLIC LICENSE Version 2, June 1991

Copyright (C) 1989, 1991 Free Software Foundation, Inc. 51 Franklin Street, Fifth Floor, Boston, MA 02110-1301, USA
Everyone is permitted to copy and distribute verbatim copies of this license document, but changing it is not allowed.

Preamble

The licenses for most software are designed to take away your freedom to share and change it. By contrast, the GNU General Public License is intended to guarantee your freedom to share and change free software—to make sure the software is free for all its users. This General Public License applies to most of the Free Software Foundation's software and to any other program whose authors commit to using it. (Some other Free Software Foundation software is covered by the GNU Lesser General Public License instead.) You can apply it to your programs, too.

When we speak of free software, we are referring to freedom, not price. Our General Public Licenses are designed to make sure that you have the freedom to distribute copies of free software (and charge for this service if you wish), that you receive source code or can get it if you want it, that you can change the software or use pieces of it in new free programs; and that you know you can do these things.

To protect your rights, we need to make restrictions that forbid anyone to deny you these rights or to ask you to surrender the rights. These restrictions translate to certain responsibilities for you if you distribute copies of the software, or if you modify it.

For example, if you distribute copies of such a program, whether gratis or for a fee, you must give the recipients all the rights that you have. You must make sure that they, too, receive or can get the source code. And you must show them these terms so they know their rights.

We protect your rights with two steps: (1) copyright the software, and (2) offer you this license which gives you legal permission to copy, distribute and/or modify the software.

Also, for each author's protection and ours, we want to make certain that everyone understands that there is no warranty for this free software. If the software is modified by someone else and passed on, we want its recipients to know that what they have is not the original, so that any problems introduced by others will not reflect on the original authors' reputations.

Finally, any free program is threatened constantly by software patents. We wish to avoid the danger that redistributors of a free program will individually obtain patent licenses, in effect making the program proprietary. To prevent this, we have made it clear that any patent must be licensed for everyone's free use or not licensed at all.

The precise terms and conditions for copying, distribution and modification follow.

TERMS AND CONDITIONS FOR COPYING, DISTRIBUTION AND MODIFICATION

0. This License applies to any program or other work which contains a notice placed by the copyright holder saying it may be distributed under the terms of this General Public License. The "Program", below, refers to any such program or work, and a "work based on the Program" means either the Program or any derivative work under copyright law: that is to say, a work containing the Program or a portion of it, either verbatim or with modifications and/or translated into another language. (Hereinafter, translation is included without limitation in the term "modification".) Each licensee is addressed as "you".

Activities other than copying, distribution and modification are not covered by this License; they are outside its scope. The act of running the Program is not restricted, and the output from the Program is covered only if its contents constitute a work based on the Program (independent of having been made by running the Program). Whether that is true depends on what the Program does.

1. You may copy and distribute verbatim copies of the Program's source code as you receive it, in any medium, provided that you conspicuously and appropriately publish on each copy an appropriate copyright notice and disclaimer of warranty; keep intact all the notices that refer to this License and to the absence of any warranty; and give any other recipients of the Program a copy of this License along with the Program.

You may charge a fee for the physical act of transferring a copy, and you may at your option offer warranty protection in exchange for a fee.

2. You may modify your copy or copies of the Program or any portion of it, thus forming a work based on the Program, and copy and distribute such modifications or work under the terms of Section 1 above, provided that you also meet all of these conditions:

- a) You must cause the modified files to carry prominent notices stating that you changed the files and the date of any change.
- b) You must cause any work that you distribute or publish, that in whole or in part contains or is derived from the Program or any part thereof, to be licensed as a whole at no charge to all third parties under the terms of this License.
- c) If the modified program normally reads commands interactively when run, you must cause it, when started running for such interactive use in the most ordinary way, to print or display an announcement including an appropriate copyright notice and a notice that there is no warranty (or else, saying that you provide a warranty) and that users may redistribute the program under these conditions, and telling the user how to view a copy of this License. (Exception: if the Program itself is interactive but does not normally print such an announcement, your work based on the Program is not required to print an announcement.)

These requirements apply to the modified work as a whole. If identifiable sections of that work are not derived from the Program, and can be reasonably considered independent and separate works in themselves, then this License, and its terms, do not apply to those sections when you distribute them as separate works. But when you distribute the same sections as part of a whole which is a work based on the Program, the distribution of the whole must be on the terms of this License, whose permissions for other licensees extend to the entire whole, and thus to each and every part regardless of who wrote it.

Thus, it is not the intent of this section to claim rights or contest your rights to work written entirely by you; rather, the intent is to exercise the right to control the distribution of derivative or collective works based on the Program.

In addition, mere aggregation of another work not based on the Program with the Program (or with a work based on the Program) on a volume of a storage or distribution medium does not bring the other work under the scope of this License.

3. You may copy and distribute the Program (or a work based on it, under Section 2) in object code or executable form under the terms of Sections 1 and 2 above provided that you also do one of the following:

- a) Accompany it with the complete corresponding machine-readable source code, which must be distributed under the terms of Sections 1 and 2 above on a medium customarily used for software interchange; or,
- b) Accompany it with a written offer, valid for at least three years, to give any third party, for a charge no more than your cost of physically performing source distribution, a complete machine-readable copy of the corresponding source code, to be distributed under the terms of Sections 1 and 2 above on a medium customarily used for software interchange; or,
- c) Accompany it with the information you received as to the offer to distribute corresponding source code. (This alternative is allowed only for noncommercial distribution and only if you received the program in object code or executable form with such an offer, in accord with Subsection b above.)

The source code for a work means the preferred form of the work for making modifications to it. For an executable work, complete source code means all the source code for all modules it contains, plus any associated interface definition files, plus the scripts used to control compilation and installation of the executable. However, as a special exception, the source code distributed need not include anything that is normally distributed (in either source or binary form) with the major components (compiler, kernel, and so on) of the operating system on which the executable runs, unless that component itself accompanies the executable.

If distribution of executable or object code is made by offering access to copy from a designated place, then offering equivalent access to copy the source code from the same place counts as distribution of the source code, even though third parties are not compelled to copy the source along with the object code.

4. You may not copy, modify, sublicense, or distribute the Program except as expressly provided under this License. Any attempt otherwise to copy, modify, sublicense or distribute the Program is void, and will automatically terminate your rights under this License. However, parties who have received copies, or rights, from you under this License will not have their licenses terminated so long as such parties remain in full compliance.

5. You are not required to accept this License, since you have not signed it. However, nothing else grants you permission to modify or distribute the Program or its derivative works. These actions are prohibited by law if you do not accept this License. Therefore, by modifying or distributing the Program (or any work based on the Program), you indicate your acceptance of this License to do so, and all its terms and conditions for copying, distributing or modifying the Program or works based on it.

6. Each time you redistribute the Program (or any work based on the Program), the recipient automatically receives a license from the original licensor to copy, distribute or modify the Program subject to these terms and conditions. You may not impose any further restrictions on the recipients' exercise of the rights granted herein. You are not responsible for enforcing compliance by third parties to this License.

7. If, as a consequence of a court judgment or allegation of patent infringement or for any other reason (not limited to patent issues), conditions are imposed on you (whether by court order, agreement or otherwise) that contradict the conditions of this License, they do not excuse you from the conditions of this License. If you cannot distribute so as to satisfy simultaneously your obligations under this License and any other pertinent obligations, then as a consequence you may not distribute the Program at all. For example, if a patent license would not permit royalty-free redistribution of the Program by all those who receive copies directly or indirectly through you, then the only way you could satisfy both it and this License would be to refrain entirely from distribution of the Program.

If any portion of this section is held invalid or unenforceable under any particular circumstance, the balance of the section is intended to apply and the section as a whole is intended to apply in other circumstances.

It is not the purpose of this section to induce you to infringe any patents or other property right claims or to contest validity of any such claims; this section has the sole purpose of protecting the integrity of the free software distribution system, which is implemented by public license practices. Many people have made generous contributions to the wide range of software distributed through that system in reliance on consistent application of that system; it is up to the author/donor to decide if he or she is willing to distribute software through any other system and a licensee cannot impose that choice.

This section is intended to make thoroughly clear what is believed to be a consequence of the rest of this License.

8. If the distribution and/or use of the Program is restricted in certain countries either by patents or by copyrighted interfaces, the original copyright holder who places the Program under this License may add an explicit geographical distribution limitation excluding those countries, so that distribution is permitted only in or among countries not thus excluded. In such case, this License incorporates the limitation as if written in the body of this License.

9. The Free Software Foundation may publish revised and/or new versions of the General Public License from time to time. Such new versions will be similar in spirit to the present version, but may differ in detail to address new problems or concerns.

Each version is given a distinguishing version number. If the Program specifies a version number of this License which applies to it and "any later version", you have the option of following the terms and conditions either of that version or of any later version published by the Free Software Foundation. If the Program does not specify a version number of this License, you may choose any version ever published by the Free Software Foundation.

10. If you wish to incorporate parts of the Program into other free programs whose distribution conditions are different, write to the author to ask for permission. For software which is copyrighted by the Free Software Foundation, write to the Free Software Foundation; we sometimes make exceptions for this. Our decision will be guided by the two goals of preserving the free status of all derivatives of our free software and of promoting the sharing and reuse of software generally.

NO WARRANTY

11. BECAUSE THE PROGRAM IS LICENSED FREE OF CHARGE, THERE IS NO WARRANTY FOR THE PROGRAM, TO THE EXTENT PERMITTED BY APPLICABLE LAW. EXCEPT WHEN OTHERWISE STATED IN WRITING THE COPYRIGHT HOLDERS AND/OR OTHER PARTIES PROVIDE THE PROGRAM "AS IS" WITHOUT WARRANTY OF ANY KIND, EITHER EXPRESSED OR IMPLIED, INCLUDING, BUT NOT LIMITED TO, THE IMPLIED WARRANTIES OF MERCHANTABILITY AND FITNESS FOR A PARTICULAR PURPOSE. THE ENTIRE RISK AS TO THE QUALITY AND PERFORMANCE OF THE PROGRAM IS WITH YOU. SHOULD THE PROGRAM PROVE DEFECTIVE, YOU ASSUME THE COST OF ALL NECESSARY SERVICING, REPAIR OR CORRECTION.

12. IN NO EVENT UNLESS REQUIRED BY APPLICABLE LAW OR AGREED TO IN WRITING WILL ANY COPYRIGHT HOLDER, OR ANY OTHER PARTY WHO MAY MODIFY AND/OR REDISTRIBUTE THE PROGRAM AS PERMITTED ABOVE, BE LIABLE TO YOU FOR DAMAGES, INCLUDING ANY GENERAL, SPECIAL, INCIDENTAL OR CONSEQUENTIAL DAMAGES ARISING OUT OF THE USE OR INABILITY TO USE THE PROGRAM (INCLUDING BUT NOT LIMITED TO LOSS OF DATA OR DATA BEING RENDERED INACCURATE OR LOSSES SUSTAINED BY YOU OR THIRD PARTIES OR A FAILURE OF THE PROGRAM TO OPERATE WITH ANY OTHER PROGRAMS), EVEN IF SUCH HOLDER OR OTHER PARTY HAS BEEN ADVISED OF THE POSSIBILITY OF SUCH DAMAGES



EDIMAX
NETWORKING PEOPLE TOGETHER